







CHIUSINO CIRCOLARE

-  ROUND manhole cover
-  Trappe RONDE
-  Tapa CIRCULAR
-  RUNDE Klapptür
-  КРУГЛАЯ крышка люка
-  圆形人孔盖

COPERCHIO COVER	C
TELAIO FRAME	T
VOLANTINO HANDWHEEL	V
G. COPERCHIO G. COVER	GC
G. TELAIO G. FRAME	GT

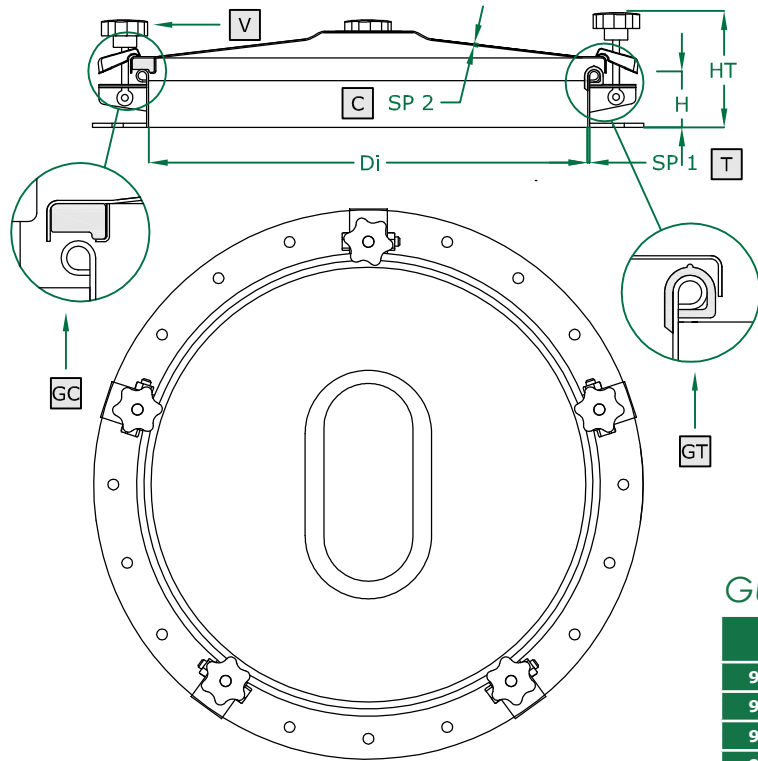

980.W SERIE

220/300/400/500/600 DN
Rev 0



GUARNIZIONE TELAIO / GASKET ON FRAME

ART	DN	Di	SP2	V (nr)	HT (standard)	BAR max: (standard)	COVER type:	GASKET code:	KG (standard)
979.W	220	220	1,0	3	105	0,2	CA	120 702	3,3
980.W	300	295	1,5	3	110	0,2	CA	120 703	4,7
982.W	400	395	1,5	4	112	0,2	CA	120 704	7,0
984.W	500	500	2,0	5	115	0,2	CA	120 705	11,8
985.W	600	600	2,0	6	115	0,2	CA	120 706	14,4

GUARNIZIONE COPERCHIO / GASKET ON COVER

ART	DN	Di	SP2	V (nr)	HT (standard)	BAR max: (standard)	COVER type:	GASKET code:	KG (standard)
979B.W	220	220	1,0	3	105	0,2	CA	120 802	3,3
980B.W	300	295	1,5	3	110	0,2	CA	120 803	4,7
982B.W	400	395	1,5	4	112	0,2	CA	120 804	6,6
984B.W	500	500	2,0	5	115	0,2	CA	120 805	11,8
985B.W	600	600	2,0	6	115	0,2	CA	120 806	14,4

	STANDARD		OPTIONAL			
H X SP1	100 X 2	150 X 2	200 X 2	250 X 2	300 X 2	...
TELAIO	SAT	MPL		BA		FIO
GUARNIZIONE	PARA	EPDM	NEOPRENE	NBR	SILICONE	VITON
VOLANTINO	125 001 V	125 021	125 022	125 023	125 024	125 031
FORO	NO	33	42	48	50	...