

CHIUSINO RETTANGOLARE apertura esterna

- RECTANGULAR manhole outwards opening
- Trappe RECTANGULAIRE avec ouverture à l'extérieur
- Tapa RECTANGULAR con apertura externa
- RECHTECKIGE Klapptür, Aussenöffnung
- ПРЯМОУГОЛЬНАЯ крышка люка с внешним открытием
- 长方形人孔盖

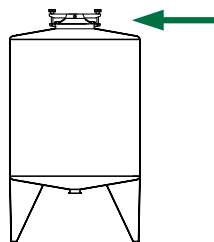

654 ART
400 X 280 mm
Rev 0

COPERCHIO COVER	C
TELAIO FRAME	T
BRACCIO ARM	B
VOLANTINO HANDWHEEL	V
GUARNIZIONE GASKET	G

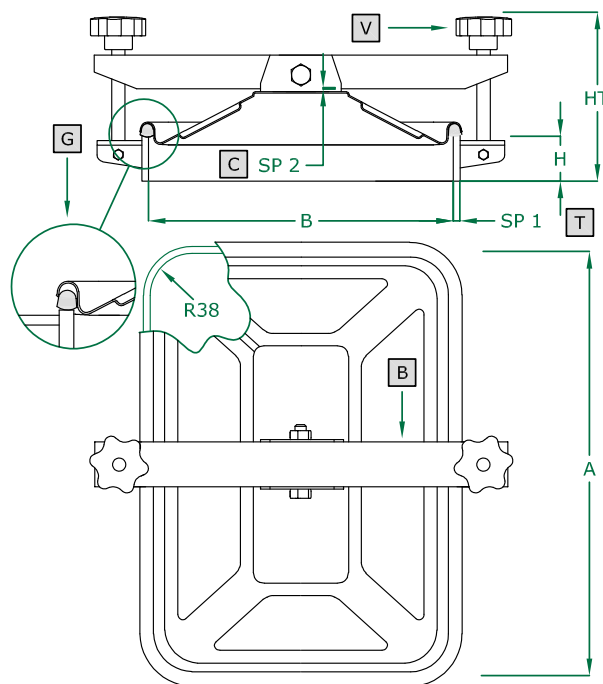

	STANDARD		OPTIONAL			
H X SP1	50 X 6		100 X 6			
TELAIO	SAT		MPL			
GUARNIZIONE	EPDM	NEOPRENE	NBR	SILICONE	VITON	
VOLANTINO	125 001 V NYLON	125 021 V NYLON	125 022 CHROME P.	125 023 S. STEEL	125 024 ALUMINIUM	125 031 S. STEEL

ART	A	B	SP2	HT (STANDARD)	BAR MAX: (STANDARD)	COVER type:	GASKET code:	KG (STANDARD)
654	405	275	1,0	155	0,1	CN	120 617	6,5