

CHIUSINO CIRCOLARE apertura a ribaltamento e bandiera

- ROUND manhole cover with back-side and side-swing opening
- Trappe RONDE avec ouverture par renversement et par glissement latéral
- Tapa CIRCULAR con apertura tanto vertical como lateral
- RUNDE Klapptür mit seitlich drehbare Öffnungs- und Kippöffnungssysteme
- КРУГЛАЯ крышка люка с откидным и боковым шарнирным открытием
- 圆形人孔盖



930.W SERIE

220/300/400/500/600 DN

Rev 0

COPERCHIO COVER	C
TELAIO FRAME	T
BRACCIO ARM	B
VOLANTINO HANDWHEEL	V
G. COPERCHIO G. COVER	GC
G. TELAIO G. FRAME	GT

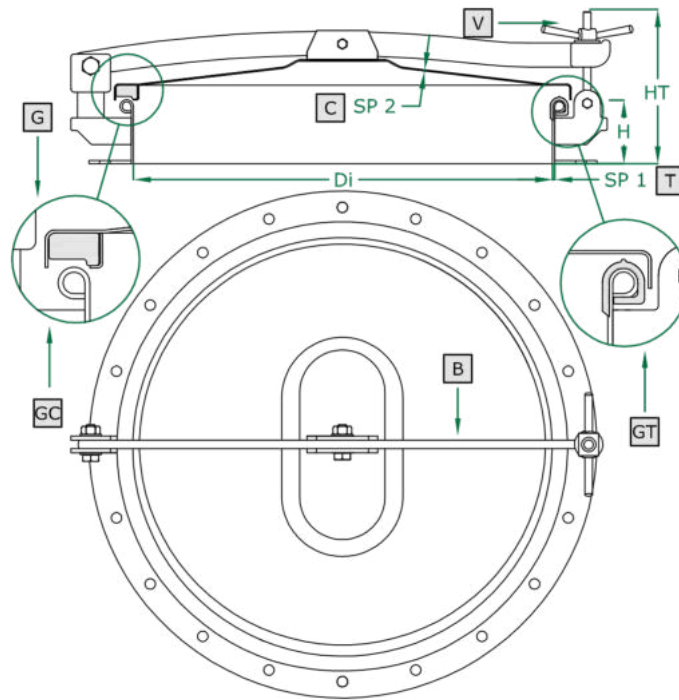
GUARNIZIONE SUL TELAIO / GASKET ON FRAME

	STANDARD	OPTIONAL				
H X SP1	100 X 2	150 X 2	200 X 2	250 X 2	...	
TELAIO	SAT	MPL	BA		FIO	
GUARNIZIONE	EPDM	NEOPRENE	NBR	SILICONE		VITON
VOLANTINO	125 001 V NYLON	125 021 V NYLON	125 022 CHROME P.	125 023 S. STEEL	125 024 ALUMINIUM	125 031 S. STEEL
FORO	NO	33	42	48	50	...

ART	DN	DI	SP2	HT (STANDARD)	BAR MAX: (STANDARD)	COVER type:	GASKET code:	KG (STANDARD)
929.W	220	220	1,0	150	0,04	CA	120 702	4,2
930.W	300	295	1,2	155	0,03	CA	120 703	5,0
932.W	400	395	1,5	160	0,02	CA	120 704	6,5
934.W	500	500	2,0	165	0,02	CA	120 705	8,1
935.W	600	600	2,0	170	0,01	CA	120 706	9,8